Product introduction for:

Gynecological and Obstetrical instruments

episiotomy scissors



F30150 Braun-Stadler scissors, episiotomy, 18cm



FXQ040 15cm



FXQ050, 18CM



FXQ060, 22CM

Umbilical cord scissors

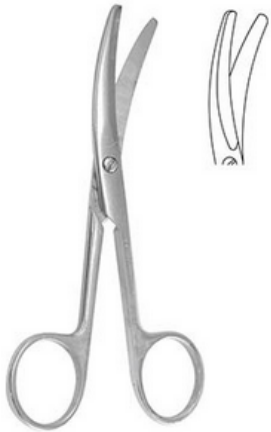

F30140 Umbilical cord scissors, 14cm



FXQ010 umbilical cord scissors, 11cm

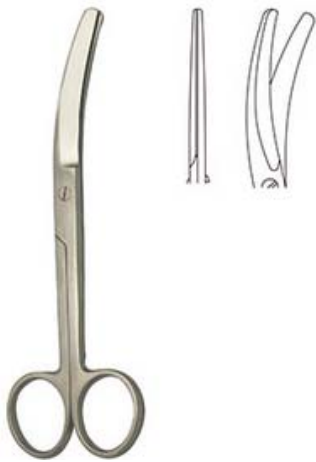

FXQ020, 14cm angled to right

FXQ030, 16cm angled to right

UTERINE SCISSORS



STRAIGHT

FXQ100 20cm 头宽6
FXQ120 20cm 头宽8

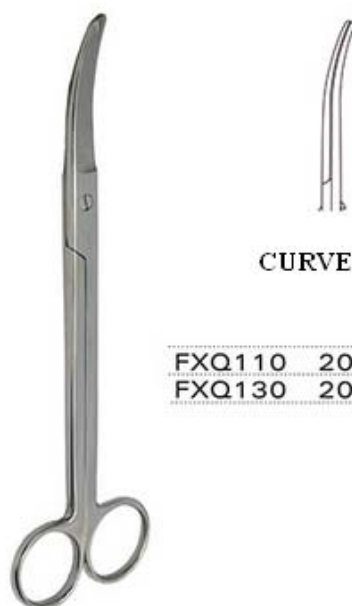

CURVED

FXQ110 20cm 头宽6
FXQ130 20cm 头宽8

OTHER SCISSORS



FXQ070, 18cm scissors, Caesarean



FXQ080, VAGINAL SCISSORS 22cm



FXQ090, VAGINAL SCISSORS 24cm



Uterine Tenaculum forceps, Teale
F10220, 25cm, cvd

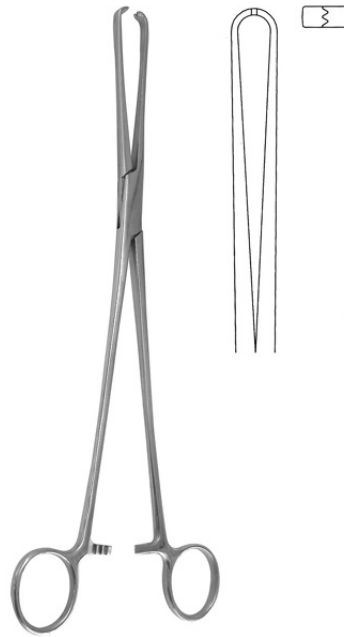

Uterine Tenaculum forceps, Teale
F10230, 25cm str



F30160 30cm



F30170 30cm



Uterine Dressing forceps
FXP010, 25CM, CVD



Uterine Dressing forceps
FXP020, 26CM Bozerman



Uterine Dressing forceps
FXP030, 25cm STR
FXP040, 25CM CVD



FXP050	20cm
FXP060	22cm
FXP070	24cm





Uterine forceps, cvd



uterine forceps, str



	3x4teeth	2x3teeth
Cvd	FXP080, 18cm	
	FXP090, 22cm	
	FXP110, 25cm	FXP130,25cm
str	FXP100, 25cm	FXP120,25cm



FXP140 **25cm**



FXP160 **20cm**
FXP170 **25cm**



FXP200 **20cm**



FXP210 **26cm**



Uterine forceps
FXP150, 28cm single prong

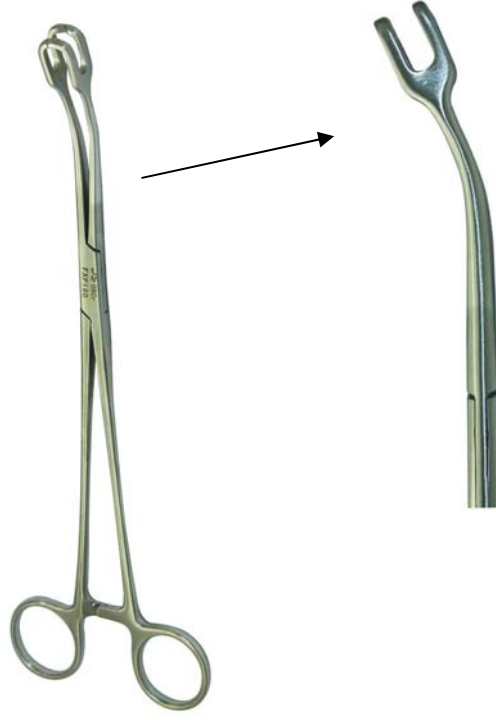

Uterine forceps
FXP180, 25cm two prongs



Str.

FXP240 32cm



Cvd.

FXP250 32cm



FXP260 24cm

Cardinal Ligament Forceps



FXP330 22cm

Caesarean Birth Forceps



直
Str.

FXP340 20cm



弯
Cvd.

FXP350 20cm



FXP360 20cm



FXP310 24cm



FXP320 22cm



FXP370 20cm



Str.

FXP380 20cm



Cvd.

FXP390 20cm



直
Str.

FXP400 25cm



弯
Cvd.

FXP410 25cm



FXP420 25cm



FXZ050 34.5cm



FAU010	22cm	▲
FAU080	25cm	▲
FAU150	28cm	▲



FAU020	22cm	65x15
FAU090	25cm	78x15
FAU160	28cm	85x15



FAU030	22cm	62x20
FAU100	25cm	72x20
FAU170	28cm	80x20



FAU040	22cm	55x25
FAU110	25cm	65x25
FAU180	28cm	75x25



FAU050	22cm	50x90°
FAU120	25cm	55x90°
FAU190	28cm	55x90°



FAU070	22cm	66x20
FAU140	25cm	70x20
FAU210	28cm	82x22



FAU060	22cm	62x20
FAU130	25cm	72x23
FAU200	28cm	80x27



RETRACTORS



F10100 25cm 40x120 FXB010 18cm 13x56 FXB020 18cm 10x60



FXB030 21cm 30x95

FXB040 26cm 30x95



FXB050 22cm 34x110
 FXB060 22cm 44x110
 FXB070 22cm 50x110

FXB080 22cm 32x115
 FXB090 22cm 40x115
 FXB100 22cm 46x115

FXB110	31cm	25x95
FXB120	31cm	38x95
FXB130	31cm	50x95
FXB140	31cm	75x95



FXB150	24cm	35x65
FXB160	24cm	35x95
FXB170	24cm	35x120

FXB180	24cm	45x65
FXB190	24cm	45x95
FXB200	24cm	45x120
FXB210	24cm	45x160

FXB220	24cm	60x65
FXB230	24cm	60x95
FXB240	24cm	60x120
FXB250	24cm	60x160

F10110	23.5cm	45x85
F10120	23.5cm	50x120
F10130	23.5cm	55x75
F10140	23.5cm	60x85

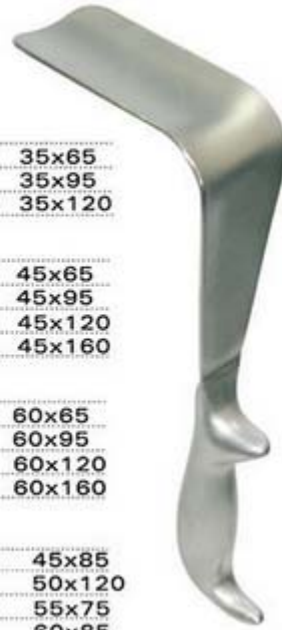

F20010	16cm	38x70
F20020	16cm	38x80
F20030	16cm	38x90



FXH010	18cm	15x70
FXH020	18cm	22x70
FXH030	18cm	30x75
FXH040	18cm	36x90



FXH050	18cm	11x75
FXH060	18cm	18x75
FXH070	18cm	26x80
FXH080	18cm	32x95



FXH090	22cm	18x110
FXH100	22cm	24x110
FXH110	22cm	30x110
FXH120	22cm	36x110





FXH130	22cm	14x115
FXH140	22cm	20x110
FXH150	22cm	26x110
FXH160	22cm	32x110



FXH210	24cm	700g
FXH220	24cm	1000g
FXH230	24cm	1500g



FXH170	29cm	叶宽20x40
FXH180	31cm	叶宽25x40
FXH190	33cm	叶宽30x40
FXH200	35cm	叶宽35x40

SURGERY



F20100	90x32
F20105	95x34

EXAM



F20110	90x22
F20120	100x30
F20130	118x37



FXI050 26cm 50x120
 FXI060 26cm 50x150
 FXI070 26cm 50x180

FXI080 32cm 25x160
 FXI090 32cm 50x160
 FXI100 36cm 25x180
 FXI110 36cm 50x180



FXI010 26cm 35x90

FXI020 29cm 45x130

FXI030 26cm 45x130
 FXI040 29cm 60x130



FAV010 17cm



FAV020 18cm



FAV030 18cm

CURETTES:



Uterine curette, sharp
FXC010, 32cm, 16mm,
FXC020, 32cm, 18mm
FXC030, 32cm, 20mm
FXC040, 32cm, 22mm
FXC050, 32cm, 24mm
FXC060, 32cm, 26mm
FXC070, 32cm, 28mm



Uterine curette, blunt
FXC230, 28cm, 9mm
FXC240, 28cm, 10mm
FXC250, 28cm, 11mm
FXC260, 28cm, 12mm
FXC270, 28cm, 14mm
FXC280, 28cm, 16mm
FXC290, 28cm, 18mm
FXC300, 28cm, 20mm

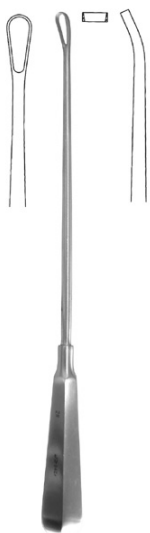

Uterine curettes sharp
U00110, 1#, tip 5
U00120, 2#, 7

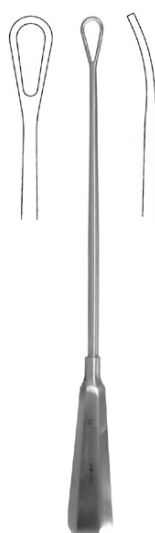

Uterine curettes blunt
U00210, 1#, tip 9
U00220, 2#, 10

U00130, 3#, 8
 U00140, 4#, 9
 U00150, 5#, 10
 U00160, 6#, 11
 U00170, 7#, 12
 U00180, 8#, 14
 U00190, 9#, 16
 U00200, 10#, 20

U00230, 3#, 11
 U00240, 4#, 12
 U00250, 5#, 14
 U00260, 6#, 16
 U00270, 7#, 20

UTERINE SOUND



F10200 28cmΦ3



FXF010 32cmΦ3
 FXF020 32cmΦ4
 FXF030 32cmΦ5

Obstetric forceps



FXZ030 30cm 单叶



F30080 40cm 后枕位



F30090 26.5cm 剖腹

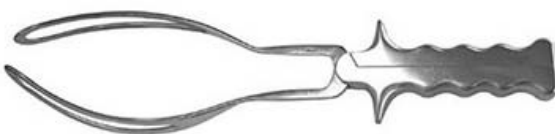

F30100 36cm 普通

CERVICAL BIOPSY FORCEPS



F10080 18cm 盖板式 长圆头

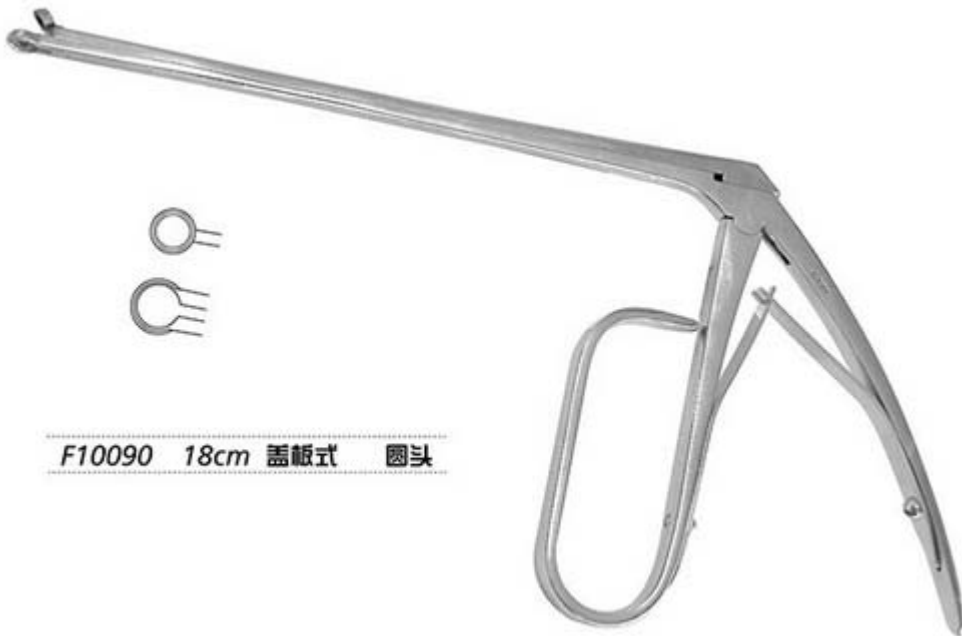

F10090 18cm 盖板式 圆头

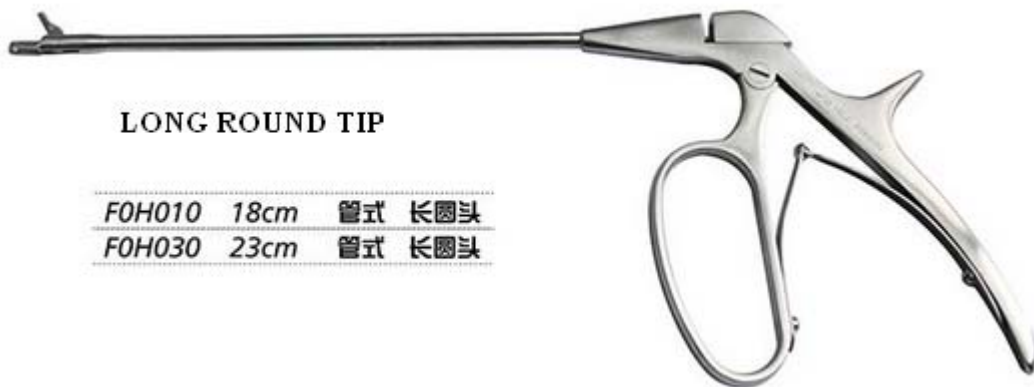

LONG ROUND TIP

- F0H010 18cm 管式 长圆头
- F0H030 23cm 管式 长圆头

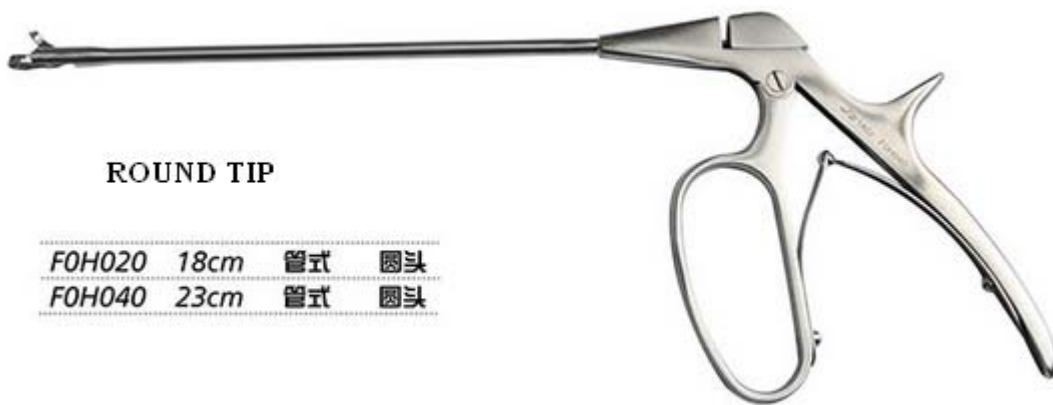

ROUND TIP

F0H020	18cm	管式	圆头
F0H040	23cm	管式	圆头

Pelvimeter

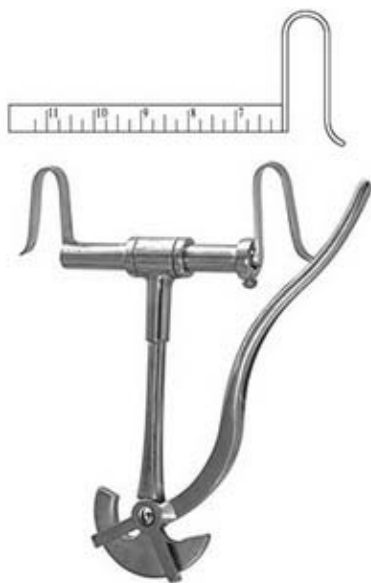

F30030



F30040



FXZ020

Induced abortion tube



F0Q010	24cm	φ5	WD
F0Q020	24cm	φ6	WD

F0Q030	24cm	φ7	WD
F0Q040	24cm	φ8	WD

cervical dilator



FOR010	4~9.5
FOR020	4~13
FOR030	3.5
FOR040	4
FOR050	4.5
FOR060	5
FOR070	5.5
FOR080	6
FOR090	6.5
FOR100	7

FOR110	7.5
FOR120	8
FOR130	8.5
FOR140	9
FOR150	9.5
FOR160	10
FOR170	10.5
FOR180	11
FOR190	11.5
FOR200	12
FOR210	13



F30010



F30020



FXZ010



F30220 22cm



F30050 Φ 55
F30060 Φ 65

Ligament Fixing Forceps

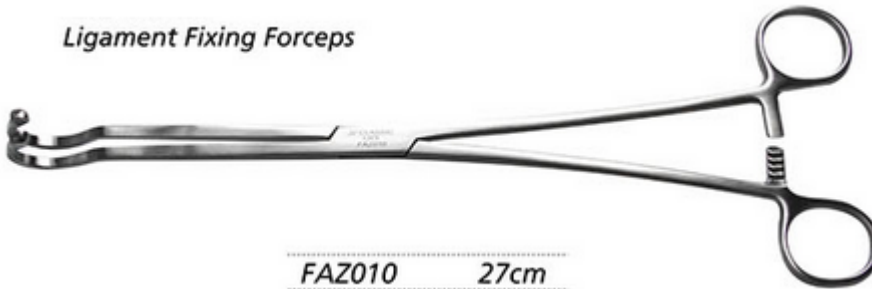

FAZ010 27cm



FAZ020 25cm

Vaginal Plate



FAZ030 25cm

Myoma Elevator



FAZ040 28cm

Spermaduct Hooks



U00009 14cm

Oviduct Plate



U00030 15cm



U00040 25cm



U00050 16cm

Ring Placing Fork



U00310 28cm

IUD Extraction Hook



U00320 28cm







SA0161 gyn set SSF-1



SA0171 GYN SET SSF-2



SA0150 DELIVERY SET



SA0101 Induced abortion set